

1	Steel Cable (C)					
	6x19+1PP		7x19 Galvanised (G)		7x19 Stainless steel (SS)	
Cable Dia.	Article (A)	Min. Breaking Load (MBL)	Article (A)	Min. Breaking Load (MBL)	Article (A)	Min. Breaking Load (MBL)
Ø 3mm	25212	4874 N	25012	4603 N	25912	5747 N
Ø 4mm	25213	8605 N	25013	8183 N	25913	10216 N
Ø 5mm	25214	13539 N	25014	12788 N	25914	13539 N

2	Cable Thimble (CT)	
	Cable Dia.	Article
	Ø 3mm	25801
	Ø 4mm	25802
	Ø 5mm	25803

3	Cable Collar eight-shape (CC)		
	Cable Dia. (CD)	Article (A)	No. of Compressions (NOC)
	Ø 3mm	25101	3
	Ø 4mm	25102	3
	Ø 5mm	25103	4

4	Cable Collar eight-shape (CC)	
	Cable Dia. (CD)	Size after pressing (SAP)
	Ø 3 mm	Max. 9 mm
	Ø 4 mm	Max. 10 mm
	Ø 5 mm	Max. 11.5 mm

	DE	ES	FR	IT	NL	PL	CS
C	Stahlseil	Cable de acero	Câble en acier	Cavo acciaio	Staalkabel	Linka stalowa	Ocelové lanko
CT	Öse für Stahlkabel	Ojo para cable en acero	Guide pour câble d'acier	Redancia	Punkous voor staalkabel	Kausza linki do linek stalowych	Očko lanka
CC	Alu-Presshülse für Stahlseil, achtförmig	Opresor de aluminio ovalado para cables de acero	Manchon aluminium pour des câbles en aciers, en forme de huit	Morsetto per cavo	Achtvormige Aluminium Kabelpershuls	Aluminiowa obejma do linek stalowych, w kształcie ósemki	Lanková objímka s osmičkovým profilem
A	Artikel	Artículo	Article	Articolo	Artikel	Artykuł	Položka
MBL	Minimale Bruchkraft	Fuerza de rotura mínima	Force de rupture minimale	Min. carico rottura	Minimale breekkracht	Minimalna siła zrywająca	Minimální pevnost v tahu
CD	Kabeldurchmesser	Diámetro del cable	Diamètre du câble	Diametro del cavo	Kabel diameter	Średnica kabla	Průměr lanka
SH	Druckloch	Agujero de presión	Trou de pression	Foro piombo	Persgat	Otwór ciśnieniowy	Otvor
NOC	Anzahl der Kompressionen	Cantidad de compresiones	Nombre de compressions	Numero di compressioni	Aantal compressies	Liczba uciśnień	Počet kompresí
SAP	Größe nach dem Drücken	Tamaño después de presionar	Dimension après avoir appuyé	Misura dopo compressione	Maat na persing	Rozmiar po naciśnięciu	Velikost po kompresi
G	Galvanisierter Stahl	Acero galvanizado	Acier galvanisé	Acciaio zincato	Gegalvaniseerd	Stal galwanizowana	Pozinkovaná ocel
SS	Rostfreier Stahl	Acero inoxidable	Acier inoxydable	Acciaio inossidabile	Roestvrij Staal	Stal nierdzewna	Nerezová ocel

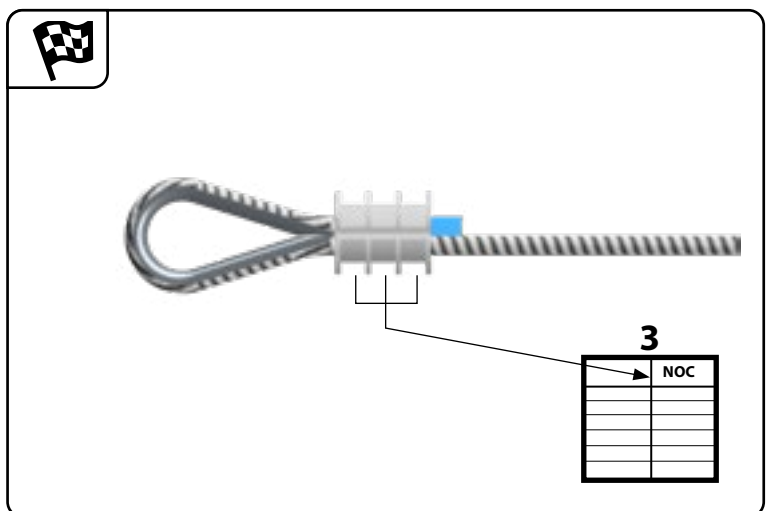
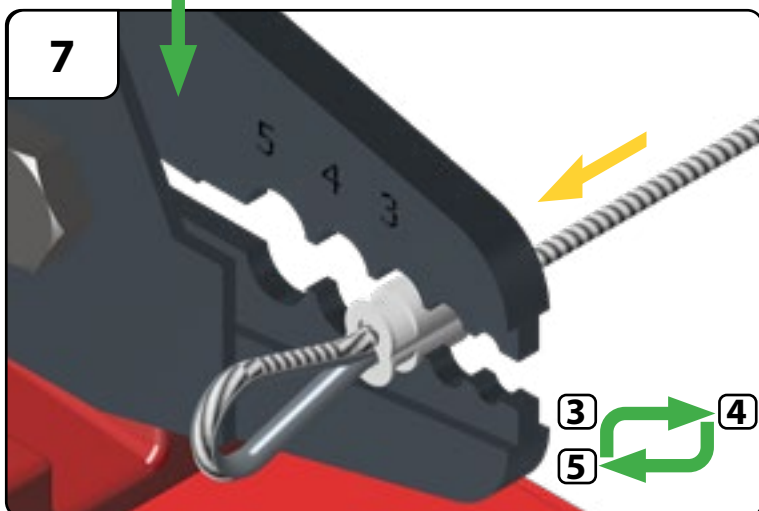
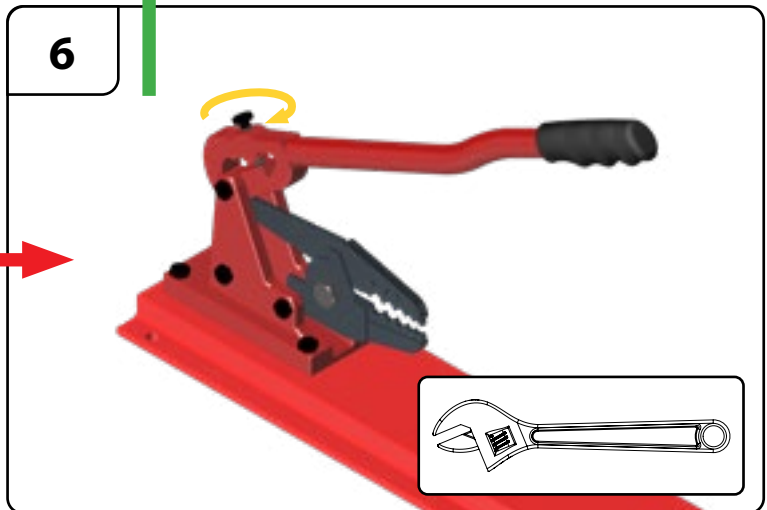
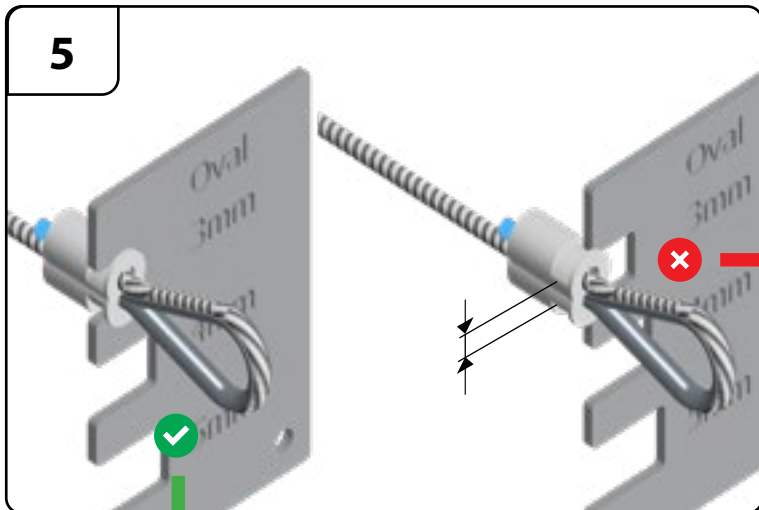
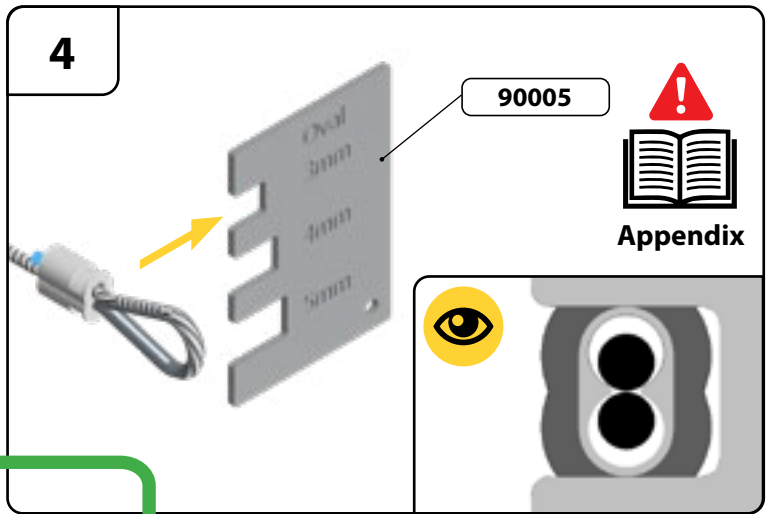
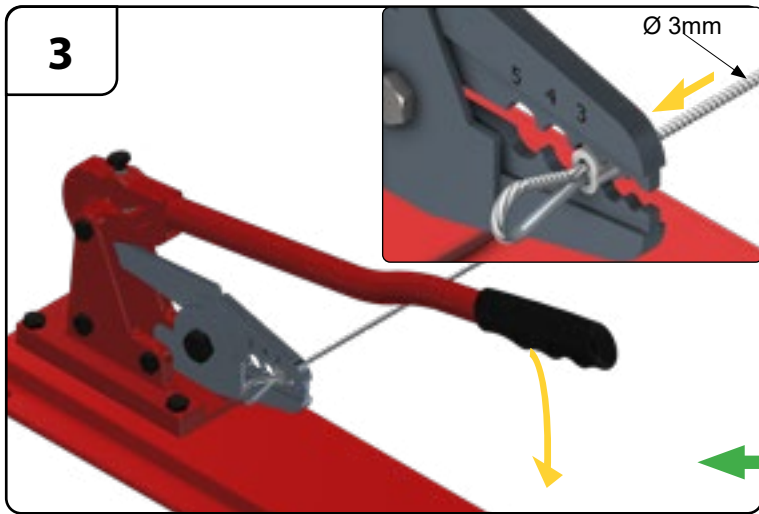
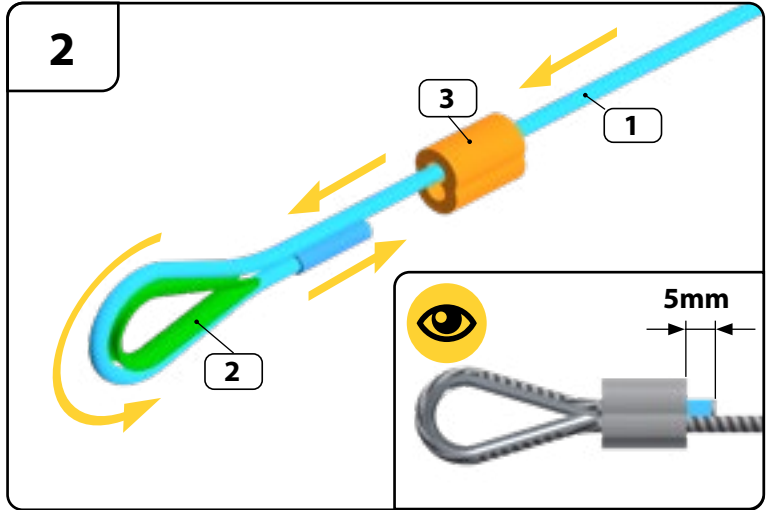
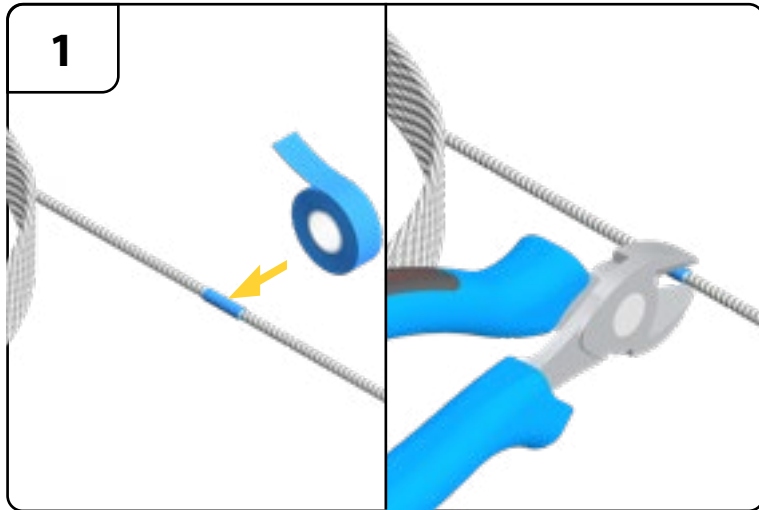

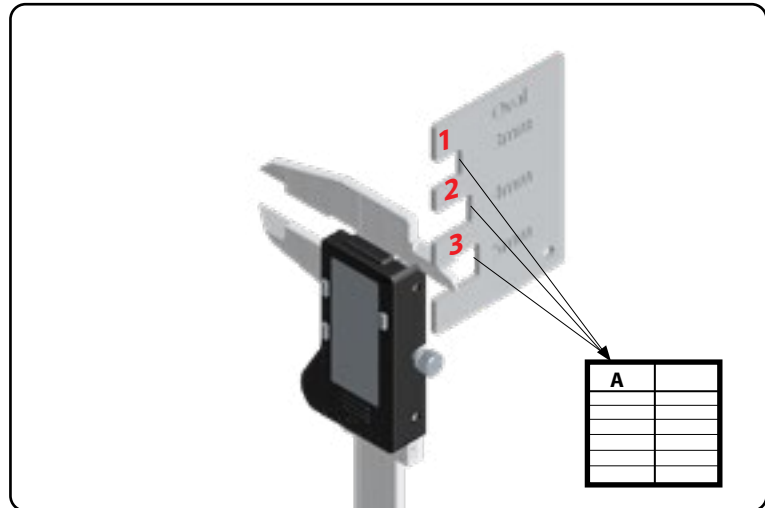
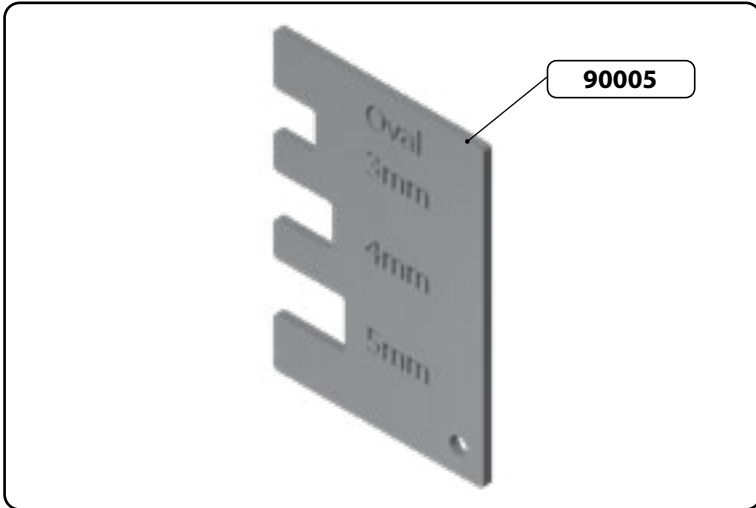

A		
1	Ø 3 mm	Max. 9 mm
2	Ø 4 mm	Max. 10 mm
3	Ø 5 mm	Max. 11.5 mm

- (EN) Measure openings 1 to 3 from 90005 tool after 500x or once every 3 months.
- (DE) Messen Sie die Öffnungen 1 bis 3 des 90005-Werkzeugs nach 500x oder einmal alle 3 Monate.
- (ES) Mida las aberturas 1 a 3 de la herramienta 90005 después de 500x o una vez cada 3 meses.
- (FR) Mesurez les ouvertures 1 à 3 de l'outil 90005 après 500x ou une fois tous les 3 mois.
- (IT) Misurare le aperture da 1 a 3 dello strumento 90005 dopo 500 volte o una volta ogni 3 mesi.
- (NL) Meet openingen 1 tot 3 van gereedschap 90005 na 500x of eens per 3 maanden.
- (PL) Zmierz otwory od 1 do 3 od narzędzia 90005 po 500x lub raz na 3 miesiące.
- (CS) Změřte otvory 1 až 3 z nástroje 90005 po 500x nebo jednou za 3 měsíce.