

epco

italpannelli

Kingspan

MARCEGAGLIA

meTECNO



TECNO PAN

tecse do

Components

for sectional door panels

Components

for sectional door panels

DOCOS International specializes in producing and distributing components for sectional doors, both industrial and residential. We don't produce door panels, so that is why we collaborate with a range of independent

door panel manufacturers throughout Europe. This brochure explains which of our hardware components are suitable for which panel partner.





Index

CE Certifications	4
EPCO	6
Italpannelli	8
Marcegaglia	13
Kingspan	14
Tecnopan	15
Niemetz	17
Metecno	18
Tecsedo	19
Industrial panels	20
Rollers & seals	23

epco

italpannelli

Kingspan

MARCEGAGLIA

meTECNO

Niemetz

TECNO PAN

tecse do

An overview of our certified panel and system combinations

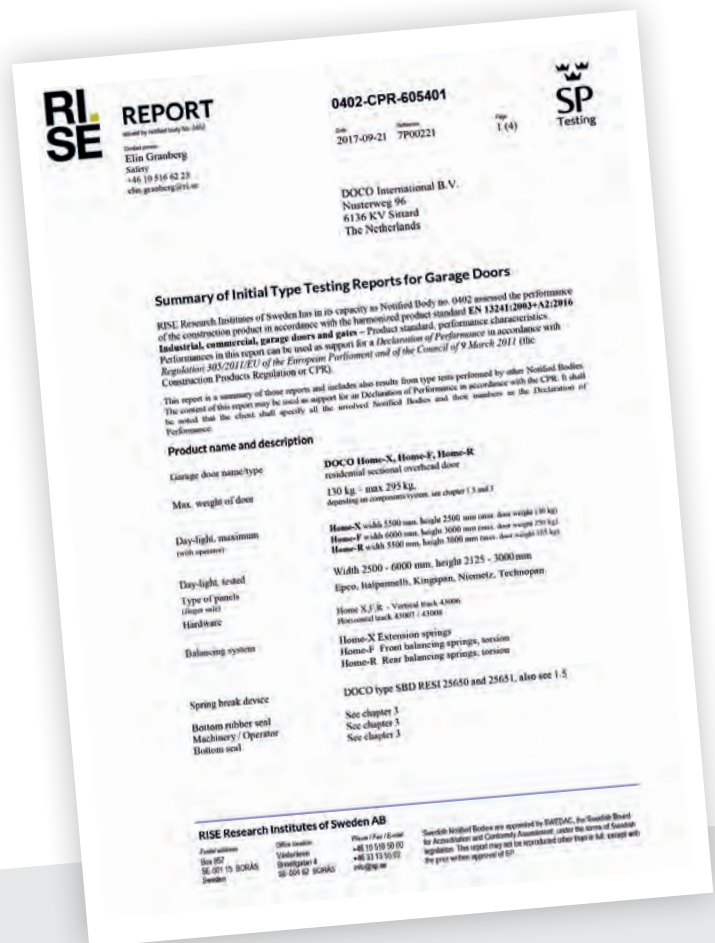



CE Certifications

Not every panel can be used on every kind of door system. That is why we have specified which panel brand is certified for use on our systems.

Please use the overview below to confirm which DOCO door system is suitable for the panel brand you are using.

For more information about our certifications, please contact a DOCO sales manager in your region or visit our website: www.doco-international.com



RI SE	Industrial systems	
	HOME	
EPCO	●	●
Italpanelli	●	●
Kingspan	●	●
Marcegaglia	●	●
Metecno	●	
Niemetz	●	●
Tecnopan	●	●
Tecsedo		●

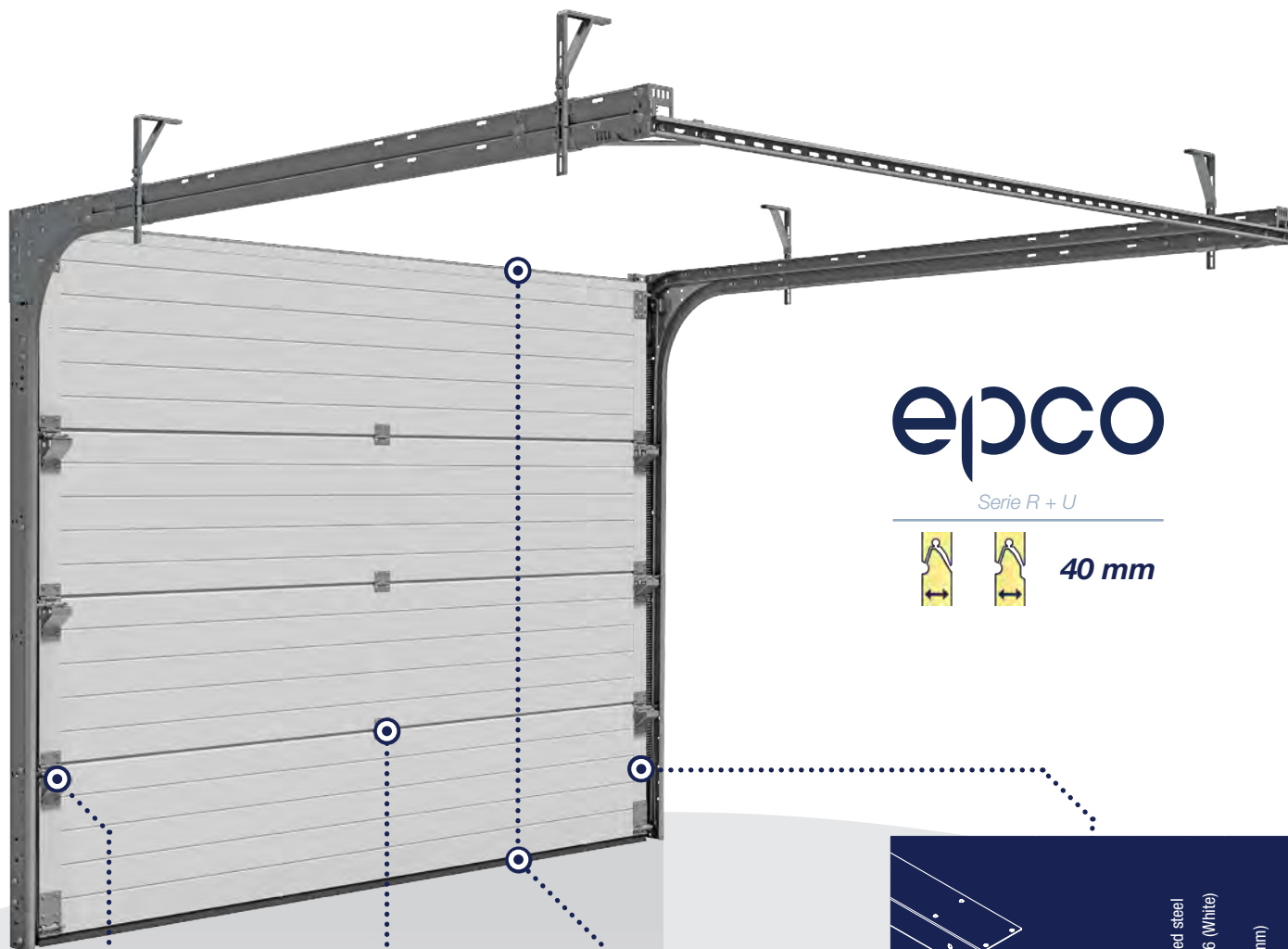



epco

Serie R + U





40 mm

	Zink plated steel RAL 9016 (White)		
230105	•		
230106			•
25736	•		•

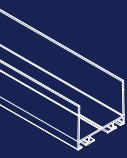
	Zink plated steel RAL 9016 (White)		
25735	•	•	

	Blank aluminum Anodized aluminum RAL 9016 (White) RAL 9011 (Black)		
820100	•		•
820101	•		•
820104	•		
820105	•		•
820110	•		
820111	•		•

	Zink plated steel RAL 9016 (White) Silent		
25167	•	•	
25165	•	•	•

	Zink plated steel RAL 9016 (White) Length (mm)		
14020	•	•	16
150113	•		16
150115		•	16

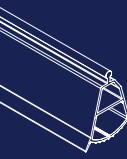
	Black		
805900	•		

	Single	Double	Left	Right	Zink plated steel RAL 9016 (White)	Height (mm)
217032	•		•		•	500
217033	•			•	•	500
217034	•		•		•	500
217035	•			•	•	500
217036	•		•		•	610
217037	•			•	•	610
217038	•		•		•	610
217039	•			•	•	610
217080	•		•		•	555
217081	•			•	•	555
217082	•		•		•	555
217083	•			•	•	555
217084	•		•		•	625
217085	•			•	•	625
217086	•		•		•	625
217087	•			•	•	625
217088	•		•		•	820
217089	•			•	•	820
217090		•	•		•	500
217091		•		•	•	500
217092		•	•		•	555
217093		•		•	•	555
217094		•	•		•	610
217095		•		•	•	610
217096		•	•		•	625
217097		•		•	•	625



epco

Serie F + G



60 mm



230110	●	Zink plated steel RAL 9016 (White)	●
--------	---	---------------------------------------	---

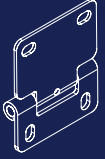

230111	●	Zink plated steel RAL 9016 (White)	●
--------	---	---------------------------------------	---

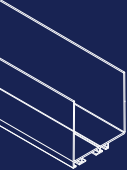

820106	●	Blank aluminum Anodized aluminum RAL 9016 (White) RAL 9011 (Black)	
--------	---	---	--



25238	●	Zink plated steel RAL 9016 (White)	●	●	●	●
25239	●	●	●	●	●	●



230112	●	Zink plated steel RAL 9016 (White)	●
--------	---	---------------------------------------	---

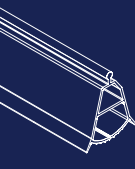

805901	●	Black	
--------	---	-------	--



	●	Zink plated steel RAL 9016 (White)	Length (mm)
14020	●	●	16
150113	●		16
150115		●	16

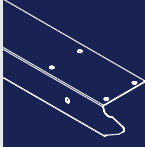

	Left	Right	Single	Double	Zink plated steel RAL 9016 (White)	Height (mm)
217100	●		●		●	500
217101		●	●		●	500
217102	●		●		●	500
217103		●	●		●	500
217104	●		●		●	610
217105		●	●		●	610
217106	●		●		●	610
217107		●	●		●	610
217108	●			●	●	500
217109		●		●	●	500
217110	●			●	●	610
217111		●		●	●	610

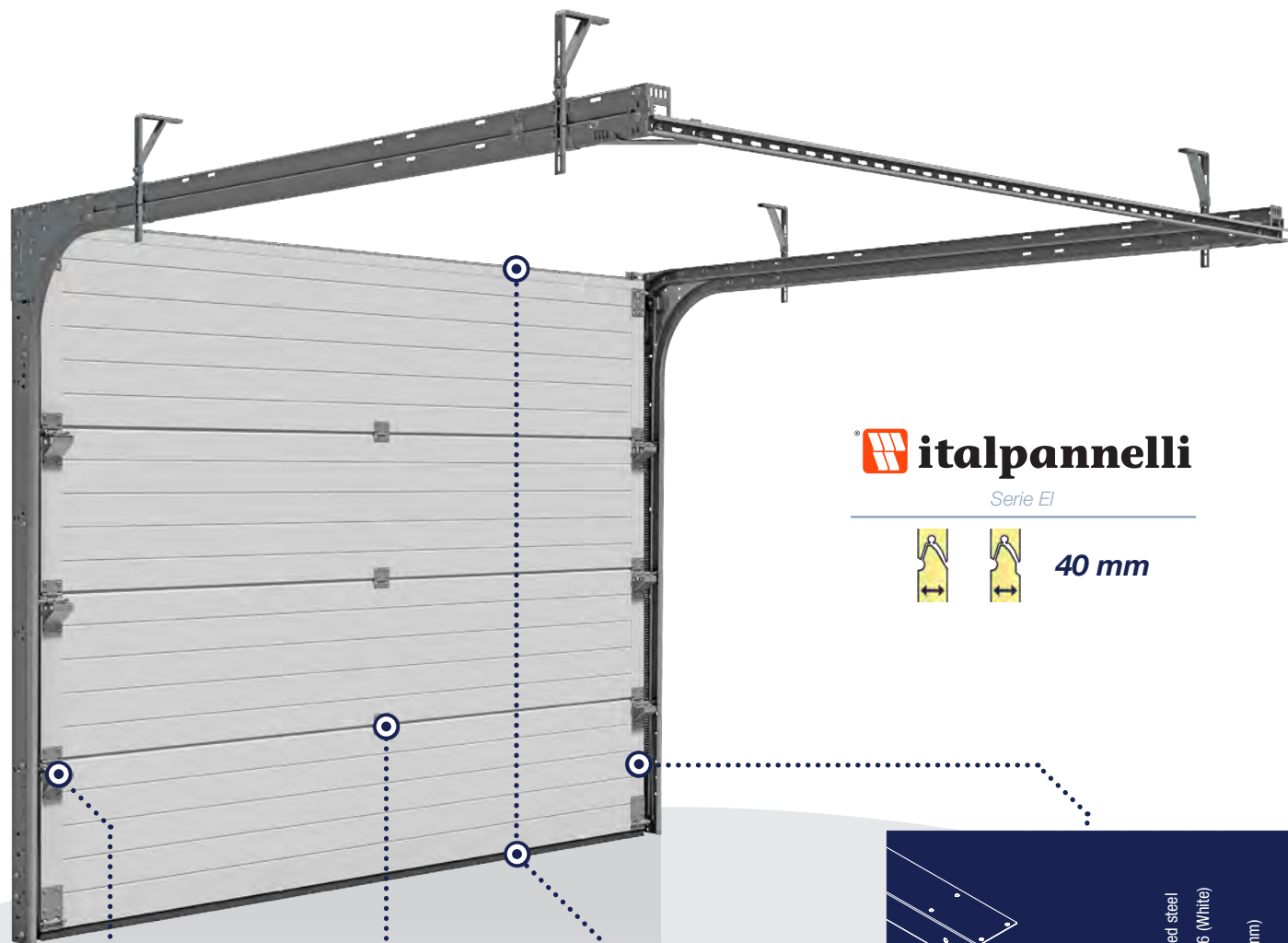



 **italpannelli**

Serie EI





40 mm

	Zink plated steel RAL 9016 (White)
230105	●
230106	●
25736	●

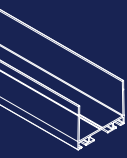
	Zink plated steel RAL 9016 (White)
25735	●

	Blank aluminum Anodized aluminum RAL 9016 (White) RAL 9011 (Black)
820100	●
820101	●
820104	●
820105	●
820110	●
820111	●

	Zink plated steel RAL 9016 (White) Silent
25167	●
25165	●

	Zink plated steel RAL 9016 (White) Length (mm)
14020	●
150113	●
150115	●

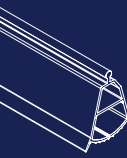
	Black
805900	●

	Single	Double	Left	Right	Zink plated steel RAL 9016 (White)	Height (mm)
217032	●		●		●	500
217033	●			●	●	500
217034	●		●		●	500
217035	●			●	●	500
217036	●		●		●	610
217037	●			●	●	610
217038	●		●		●	610
217039	●			●	●	610
217080	●		●		●	555
217081	●			●	●	555
217082	●		●		●	555
217083	●			●	●	555
217084	●		●		●	625
217085	●			●	●	625
217086	●		●		●	625
217087	●			●	●	625
217088	●		●		●	820
217089	●			●	●	820
217090		●	●		●	500
217091		●		●	●	500
217092		●	●		●	555
217093		●		●	●	555
217094		●	●		●	610
217095		●		●	●	610
217096		●	●		●	625
217097		●		●	●	625



Serie APZ



40 mm



	Zink plated steel	RAL 9016 (White)	Silent
25734	●	●	
25738	●		●



	Zink plated steel	RAL 9016 (White)
25733	●	●

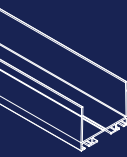

	Blank aluminum	Anodized aluminum	RAL 9016 (White)	RAL 9011 (Black)
820100	●		●	●
820101	●		●	●
820104	●			
820105	●		●	●
820110	●			
820111	●		●	

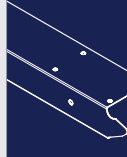

	Left	Right	Zink plated steel	RAL 9016 (White)	Height (mm)
217060	●		●		500
217061		●	●		500
217062	●			●	500
217063		●	●		500
217064	●		●		610
217065		●	●		610
217066	●			●	610
217067		●		●	610



	Zink plated steel	RAL 9016 (White)	Silent
25163	●	●	
25171	●	●	●



	Zink plated steel	RAL 9016 (White)	Length (mm)
14020	●	●	16
150113	●		16
150115		●	16
150002	●	●	25
150114	●		25
150116		●	25
14017	●		35
14027	●		35
14117	●		35

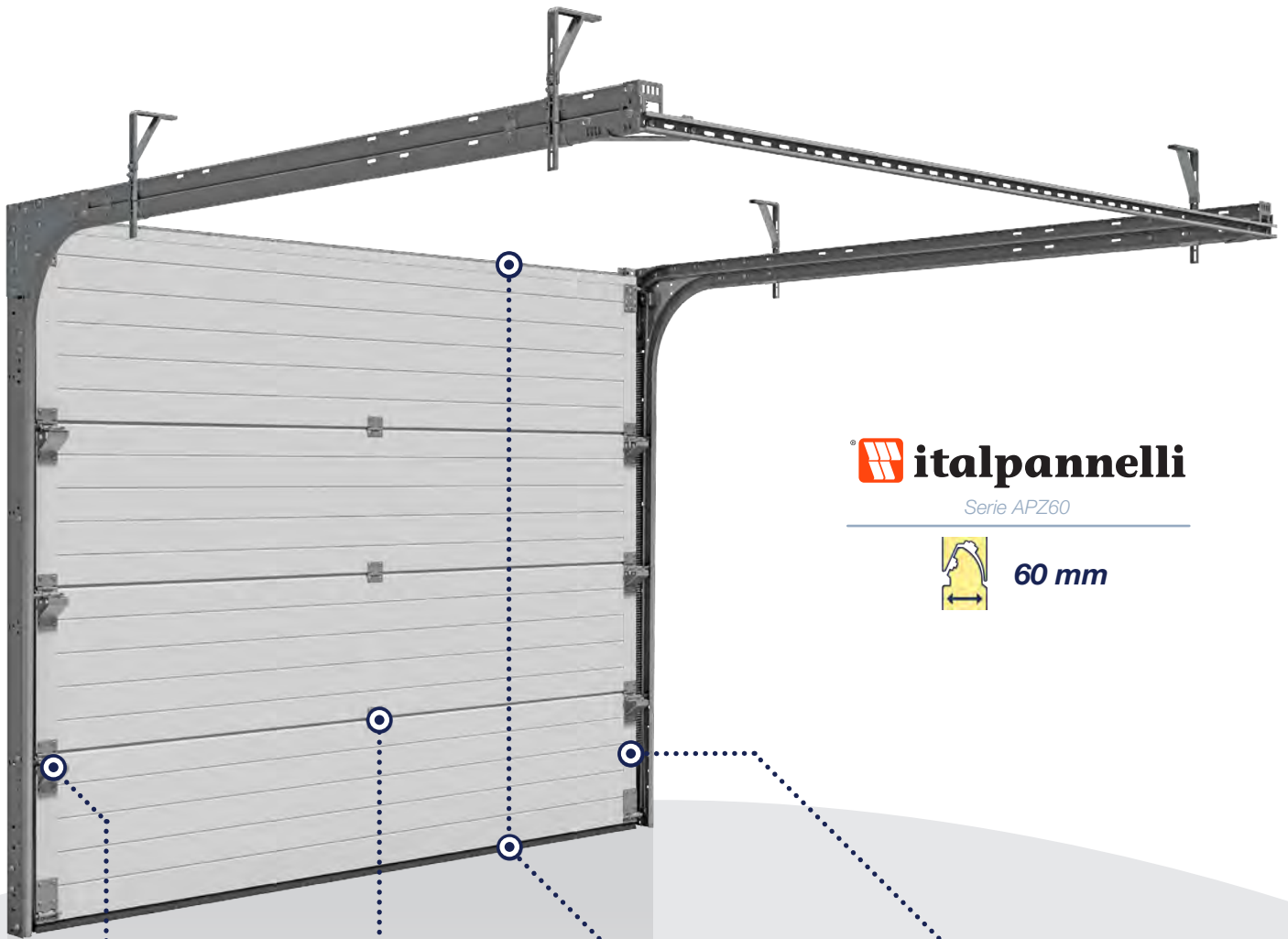

italpannelli

Serie APZ60



60 mm

230110	●	Zink plated steel RAL 9016 (White)
--------	---	---------------------------------------

230111	●	Zink plated steel RAL 9016 (White)
--------	---	---------------------------------------

820106	●	Blank aluminum Anodized aluminum RAL 9016 (White) RAL 9011 (Black)
--------	---	---

25238	●	Zink plated steel RAL 9016 (White)	●	Silent
25239	●	Zink plated steel RAL 9016 (White)	●	●

230112	●	Zink plated steel RAL 9016 (White)
--------	---	---------------------------------------

14020	●	Zink plated steel RAL 9016 (White)	16
150113	●	Zink plated steel RAL 9016 (White)	16
150115	●	Zink plated steel RAL 9016 (White)	16

	Left	Right	Single	Double	Zink plated steel RAL 9016 (White)	Height (mm)
217100	●		●		●	500
217101		●	●		●	500
217102	●		●		●	500
217103		●	●		●	500
217104	●		●		●	610
217105		●	●		●	610
217106	●		●		●	610
217107		●	●		●	610
217108	●			●	●	500
217109		●		●	●	500
217110	●			●	●	610
217111		●		●	●	610







40 mm

	Zink plated steel RAL 9016 (White)	Silent
25734	●	●
25738	●	●

	Zink plated steel RAL 9016 (White)
25733	●

	Blank aluminum	Anodized aluminum RAL 9016 (White)	RAL 9011 (Black)
820100	●	●	●
820101	●	●	●
820104	●		
820105	●	●	●
820110	●		
820111	●	●	

	Left	Right	Zink plated steel RAL 9016 (White)	Height (mm)
217060	●		●	500
217061		●	●	500
217062	●		●	500
217063		●	●	500
217064	●		●	610
217065		●	●	610
217066	●		●	610
217067		●	●	610

	Zink plated steel RAL 9016 (White)	Silent
25163	●	●
25171	●	●

	Zink plated steel RAL 9016 (White)	Length (mm)
14020	●	16
150113	●	16
150115	●	16
150002	●	25
150114	●	25
150116	●	25
14017	●	35
14027	●	35
14117	●	35



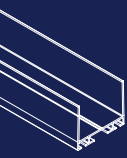

	Zink plated steel		
	RAL 9016 (White)		
230220	●	●	

	Zink plated steel		
	RAL 9016 (White)		
230222	●	●	

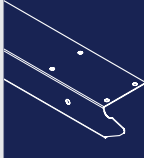
	Blank aluminum			
	Anodized aluminum			
	RAL 9016 (White)	●	●	
	RAL 9011 (Black)			
820100	●			
820101	●			
820104	●			
820105	●			
820110	●			
820111	●	●		

	Left				
	Right				
	Zink plated steel				
	RAL 9016 (White)				
	Height (mm)				
217050	●				500
217051		●			500
217052	●				500
217053		●			500
217054	●				610
217055		●			610
217056	●				610
217057		●			610

	Zink plated steel		
	RAL 9016 (White)		
	Silent		
25238	●	●	
25239	●	●	●

	Zink plated steel		
	RAL 9016 (White)		
	Silent		
230225	●	●	
230226	●	●	●

	Zink plated steel		
	RAL 9016 (White)		
	Length (mm)		
14020	●	●	16
150113	●		16
150115		●	16

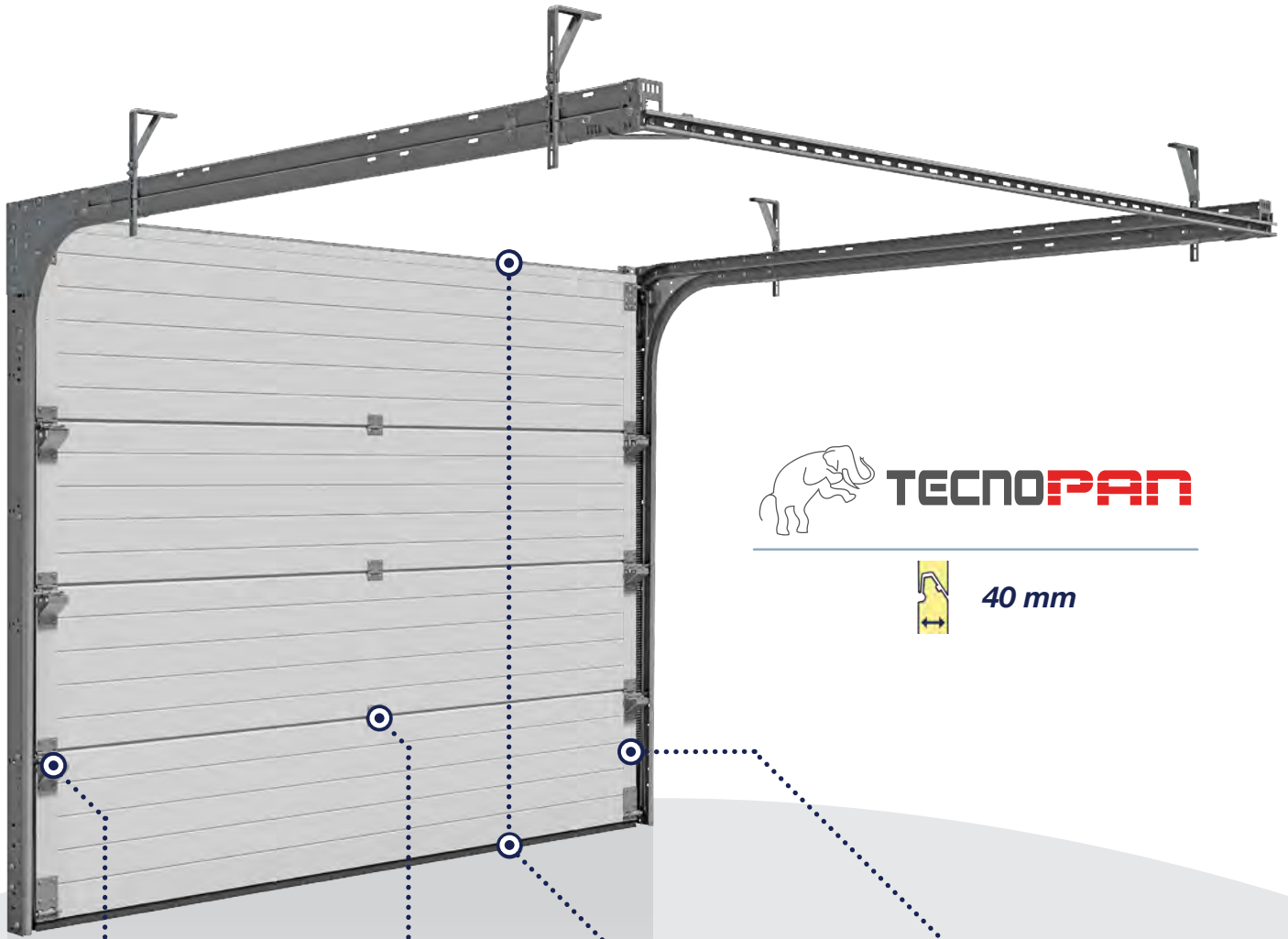



TECNO PAN





40 mm

	Zink plated steel		
	RAL 9016 (White)	•	•
230220			

	Zink plated steel		
	RAL 9016 (White)	•	•
230222			

	Zink plated steel		
	RAL 9016 (White)	•	•
	Silent		
25238			
25239			

	Zink plated steel		
	RAL 9016 (White)	•	•
	Silent		
230225			
230226			

	Blank aluminum			
	Anodized aluminum			
	RAL 9016 (White)	•	•	
	RAL 9011 (Black)			
820100		•		
820101		•		
820104		•		
820105		•		
820110		•		
820111		•		

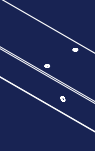
	Left				
	Right				
	Zink plated steel				
	RAL 9016 (White)				
	Height (mm)				
217050		•			500
217051			•		500
217052		•			500
217053			•		500
217054		•			610
217055			•		610
217056		•			610
217057			•		610

	Zink plated steel		
	RAL 9016 (White)	•	•
	Length (mm)		
14020		•	16
150113		•	16
150115		•	16



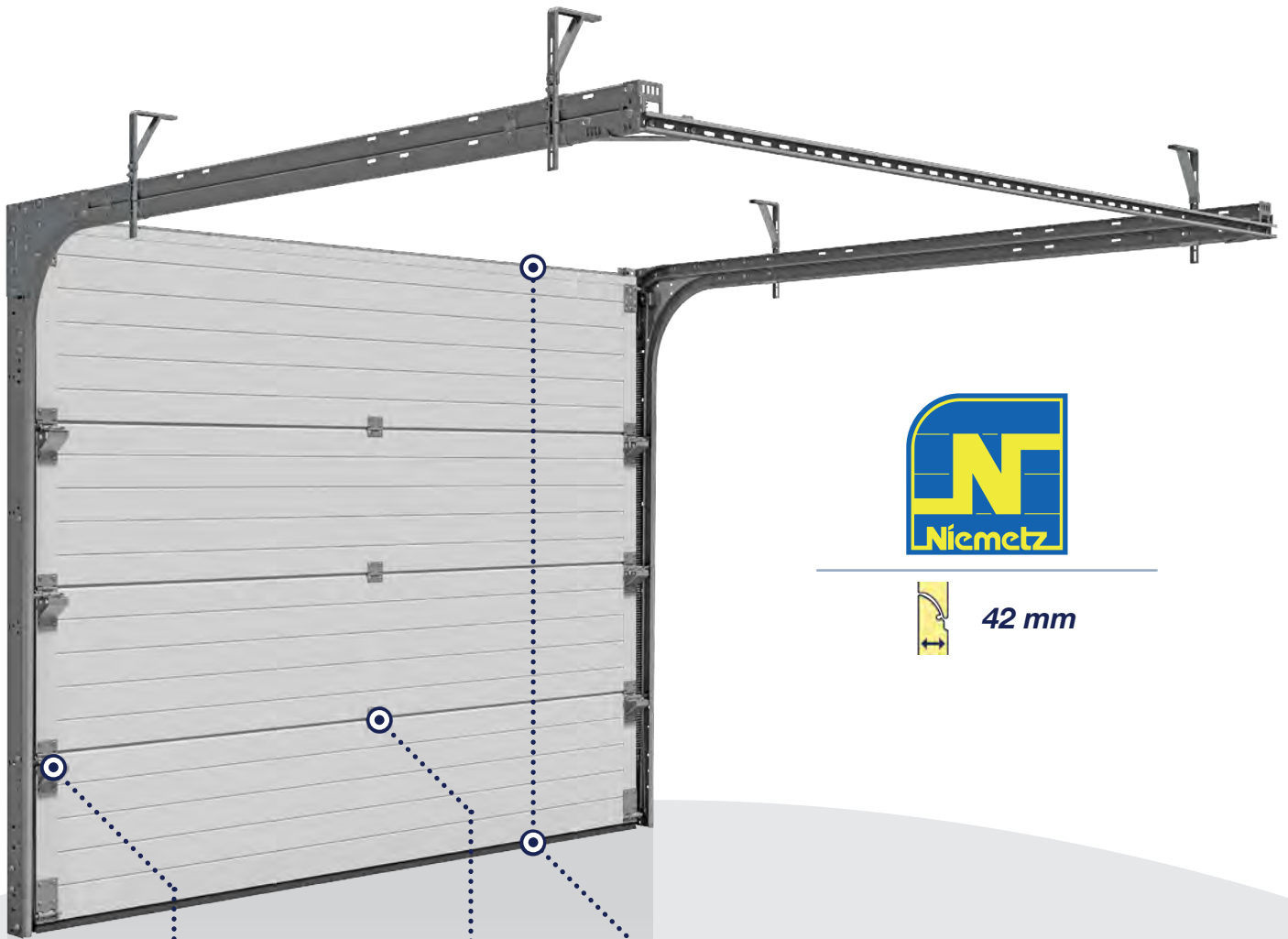

42 mm

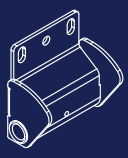

Zink plated steel
RAL 9016 (White)

230010	●		
--------	---	--	--



Zink plated steel
RAL 9016 (White)

230011	●		
--------	---	--	--

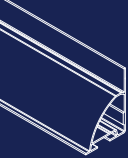

Blank aluminum
Anodized aluminum
RAL 9016 (White)
RAL 9011 (Black)

820400	●		
--------	---	--	--



Zink plated steel
RAL 9016 (White)
Length (mm)

14020	●	●	16
150113	●		16



Max. load (kg)
Length (mm)

250167	35	74
250168	35	160

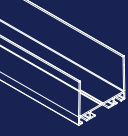

Blank aluminum
Anodized aluminum
RAL 9016 (White)
RAL 9011 (Black)

820401	●		
820402	●		



40 mm

	Zink plated steel	RAL 9016 (White)	Silent
25734	●	●	
25738	●		●

	Zink plated steel	RAL 9016 (White)
25733	●	●

	Blank aluminum	Anodized aluminum	RAL 9016 (White)	RAL 9011 (Black)
820100	●		●	●
820101	●		●	●
820104	●			
820105	●		●	●
820110	●			
820111	●		●	

	Left	Right	Zink plated steel	RAL 9016 (White)	Height (mm)
217060	●		●		500
217061		●	●		500
217062	●			●	500
217063		●		●	500
217064	●		●		610
217065		●	●		610
217066	●			●	610
217067		●		●	610

	Zink plated steel	RAL 9016 (White)	Silent
25163	●	●	
25171	●	●	●

	Zink plated steel	RAL 9016 (White)	Length (mm)
14020	●	●	16
150113	●		16
150115		●	16
150002	●	●	25
150114	●		25
150116		●	25
14017	●		35
14027	●		35
14117	●		35

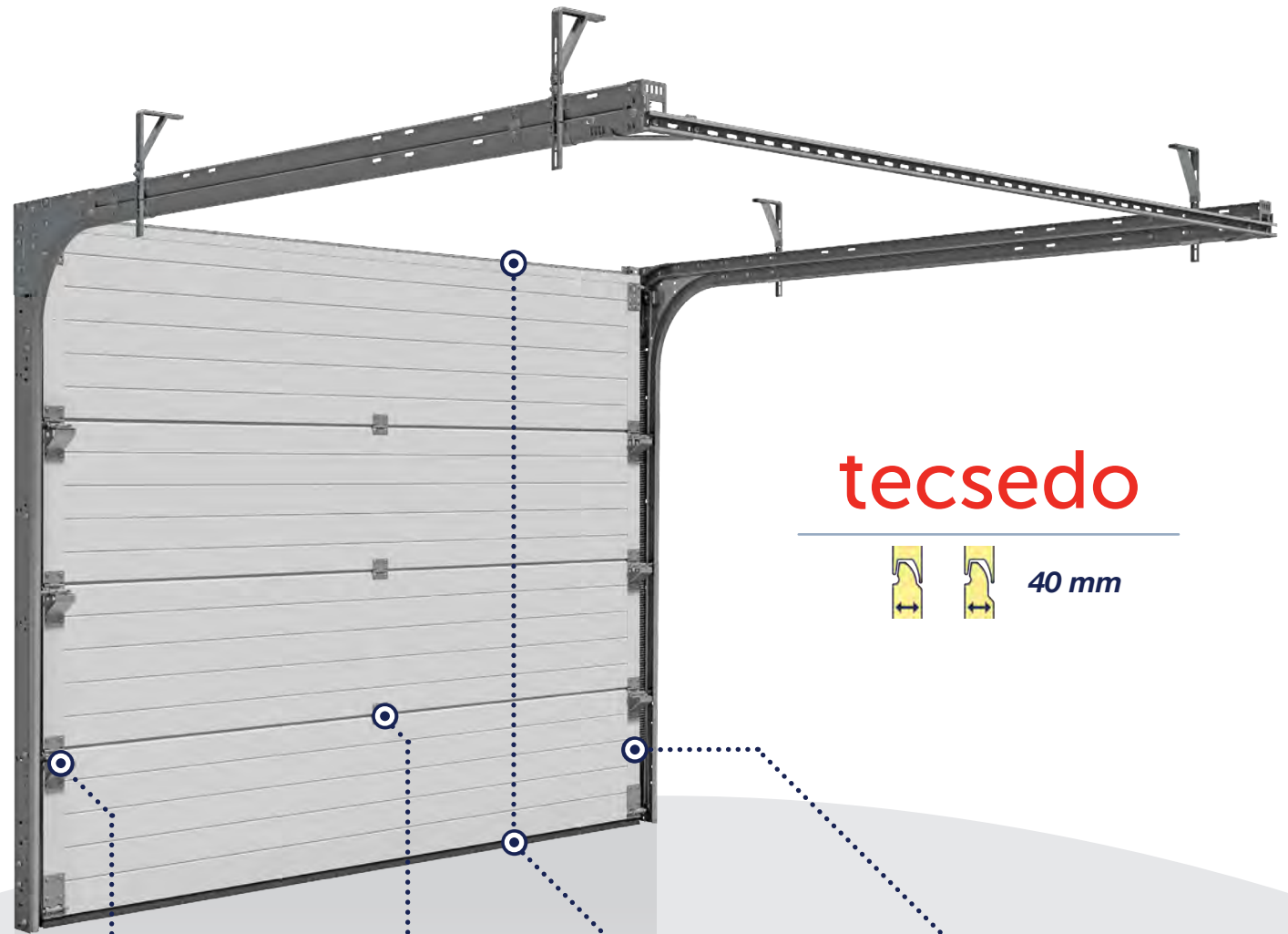

tecsedo

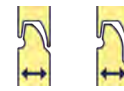

40 mm

	Zink plated steel	RAL 9016 (White)	Silent
25734	●	●	
25738	●	●	●

	Zink plated steel	RAL 9016 (White)
25733	●	●

	Blank aluminum	Anodized aluminum	RAL 9016 (White)	RAL 9011 (Black)
820100	●		●	●
820101	●		●	●
820104	●			
820105	●		●	●
820110	●			
820111	●		●	

	Left	Right	Zink plated steel	Height (mm)
217070	●		●	500
217071		●	●	500
217074	●		●	610
217075		●	●	610

	Zink plated steel	RAL 9016 (White)	Silent
25163	●	●	
25171	●	●	●

	Zink plated steel	RAL 9016 (White)	Length (mm)
14020	●	●	16
150113	●		16
150115		●	16

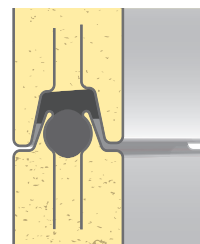
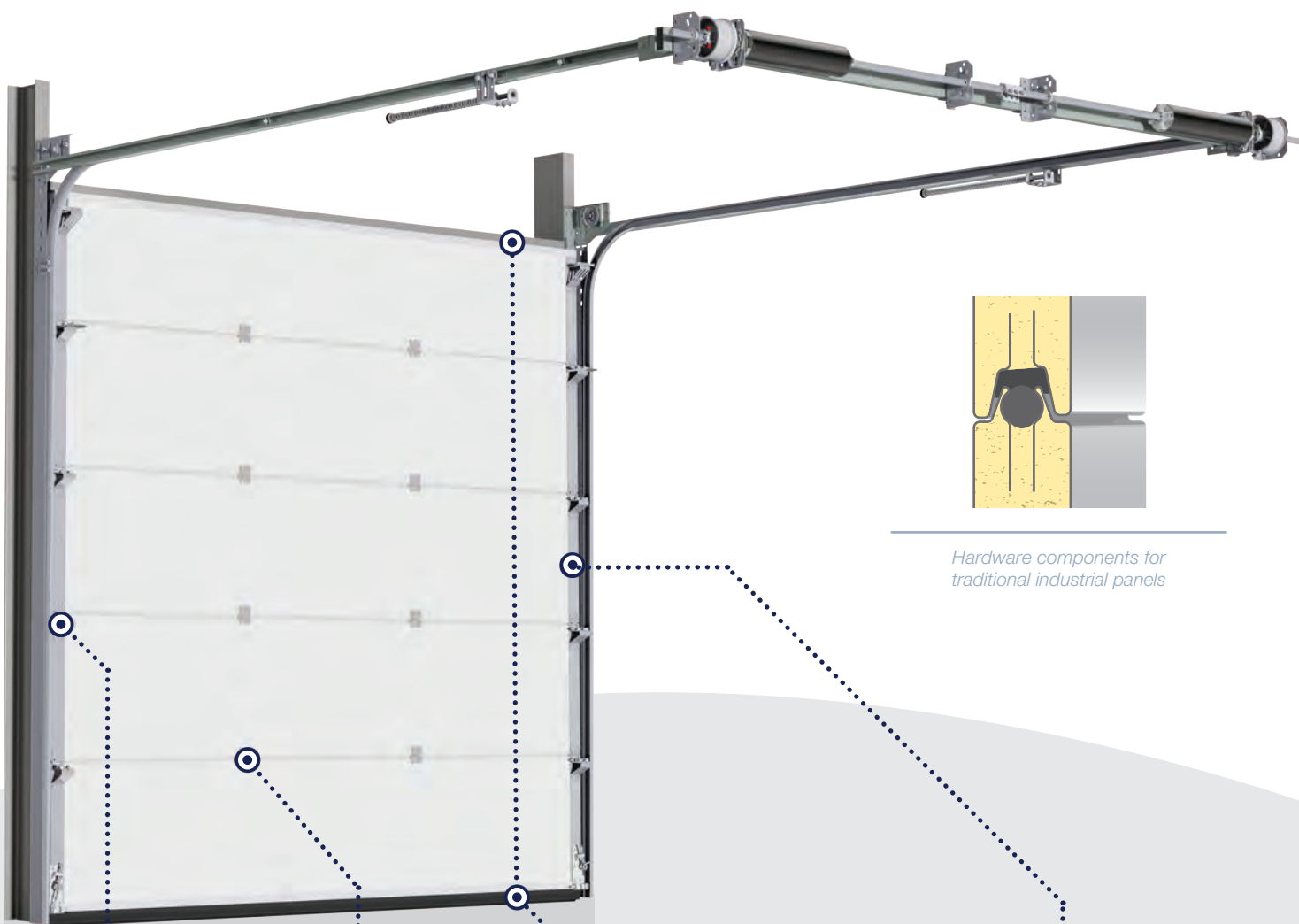

Hardware components for traditional industrial panels

	Zink plated steel	Stainless steel
25234	●	
230103	●	
25934		●

	Zink plated steel	Stainless steel
25233	●	
25933		●

	Blank aluminum	Anodized aluminum	RAL 9016 (White)	RAL 9011 (Black)	Thickness (mm)
820100	●		●	●	40
820101	●		●	●	40
820103	●				40
820104	●				40
820105	●		●	●	40
820106	●				60
820107	●				80
820111	●		●		40

	Single	Double	Zink plated steel	Stainless steel	Height (mm)	Thickness (mm)
80012-L	●		●		610	40
80013-L	●		●		488	40
80017-L	●		●		500	40
80112	●			●	610	40
80113	●			●	488	40
217124	●		●		488	60
217126	●		●		610	60
217129	●		●		500	80
217130	●		●		610	80
217148		●	●		488	80
217149		●	●		500	80
217150		●	●		610	80
217151		●	●		732	80
80010-L		●	●		610	40
80011-L		●	●		488	40
80609-L		●	●		500	40

	Zink plated steel	Stainless steel
230125	●	
25169	●	

	Zink plated steel	Stainless steel	RAL 9016 (White)
14017	●		●
14117		●	





Rollers

	Max. load (kg)	Length (mm)	Residential		Industrial	
			●	●	●	●
	35	90	●	●		
25008	35	90	●	●		
25066	60	70	●			
25068	60	170	●	●		
25229	20	100	●			
250003	35	100	●	●		
25010-E	35	90	●	●		
25011-E	35	170	●	●		

Duplex rollers

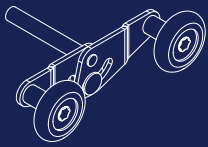
	Max. load (kg)	Length (mm)	Residential		Industrial	
			●	●	●	●
	50	102			●	
25070	50	102			●	
25161	50	164			●	
250162	35	84	●			
250167	35	84	●			
250168	35	160	●			

Bottom seals

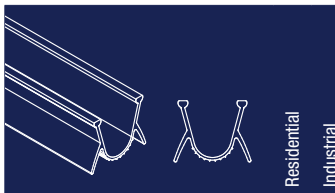
	Residential	Industrial
	●	●
80019	●	●
80042	●	●

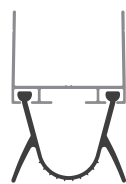

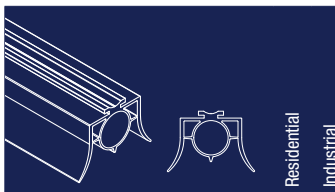
	Residential	Industrial
	●	●
825100	●	●
825103		●
825107	●	
825109	●	
825110	●	

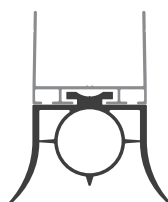

Top seals

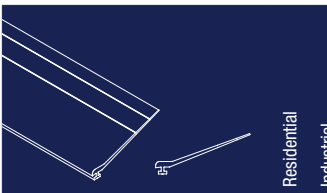
	Residential	Industrial
	●	●
80028	●	●
825101	●	●

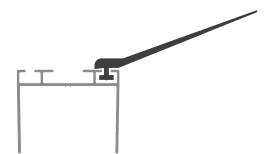

More information?

For more information please visit our website:
www.doco-international.com

If you have any questions, please do not
 hesitate to contact your local sales manager.

Subsidiaries

DOCO International B.V.

Nusterweg 96
6136 KV Sittard
The Netherlands
Phone +31 464200666
Fax +31 464526894
info@doco-international.com

**DOCO International
Central Europe S.R.O.**

Háj 352
798 12 Kralice na Hané
Czech Republic
Phone +420 582360100
Fax +420 582360300
info@doco-international.com

**DOCO International Ltd.
t/a SOMMER DOCO**

Unit B3 Elvington Industrial Estate
Elvington
York
YO41 4AR
United Kingdom
Phone +44 1904607869
Fax +44 1904607299
sales@doco-international.co.uk

DOCO SOMMER Ibérica S.L.U.

Avenida Generalitat 55
P.I. "Can Met Sidru"
08530 La Garriga - Barcelona
Spain
Phone +34 938612825
Fax +34 938716592
pedidos@doco-sommer.com

Sales Offices

SOMMER Automazioni s.r.l.

Localita Le Basse 33
38123 - Trento TN
Italy
Phone +39 0461263863
Fax +39 0461269247
italia@sommer.eu

SOMMER Polska Sp.z.o.o.

Al. Jerozolimskie 439
05 - 800 Pruszków
Poland
Phone +48 222302100
biuro@sommer-polska.pl

SOMMER Kft.

II. Rákóczi Ferenc út 277
1214 Budapest
Hungary
Phone +36 12780261
Fax +36 12764439
info@sommerkft.hu

**SOMMER Automation
& Radio Co., Ltd.**

Fengrao Road 388
201801 Shanghai, Malu County
Jiading District, Shanghai
China
Phone +86 2169153919
Fax +86 2169153155
sales@sommer-china.com.cn

